

MX802A

EUROACK®

User's Manual

Version 1.1 January 2001

ENGLISH

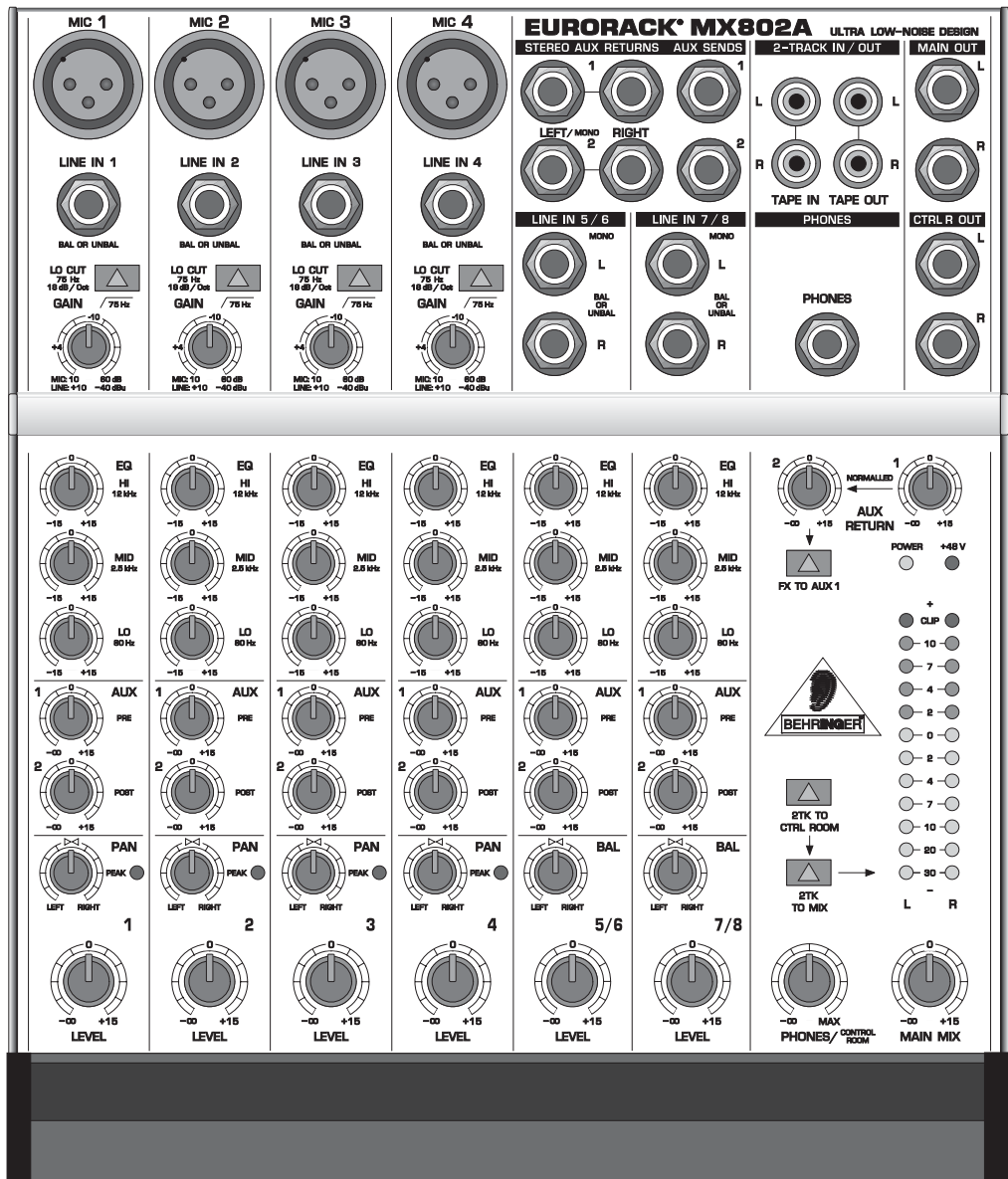

www.behringer.com

SAFETY INSTRUCTIONS

CAUTION: To reduce the risk of electric shock, do not remove the cover (or back). No user serviceable parts inside; refer servicing to qualified personnel.



WARNING: To reduce the risk of fire or electric shock, do not expose this appliance to rain or moisture.



This symbol, wherever it appears, alerts you to the presence of uninsulated dangerous voltage inside the enclosure - voltage that may be sufficient to constitute a risk of shock.



This symbol, wherever it appears, alerts you to important operating and maintenance instructions in the accompanying literature. Read the manual.

DETAILED SAFETY INSTRUCTIONS:

All the safety and operation instructions should be read before the appliance is operated.

Retain Instructions:

The safety and operating instructions should be retained for future reference.

Heed Warnings:

All warnings on the appliance and in the operating instructions should be adhered to.

Follow instructions:

All operation and user instructions should be followed.

Water and Moisture:

The appliance should not be used near water (e.g. near a bathtub, washbowl, kitchen sink, laundry tub, in a wet basement, or near a swimming pool etc.).

Ventilation:

The appliance should be situated so that its location or position does not interfere with its proper ventilation. For example, the appliance should not be situated on a bed, sofa rug, or similar surface that may block the ventilation openings, or placed in a built-in installation, such as a bookcase or cabinet that may impede the flow of air through the ventilation openings.

Heat:

The appliance should be situated away from heat sources such as radiators, heat registers, stoves, or other appliance (including amplifiers) that produce heat.

Power Source:

The appliance should be connected to a power supply only of the type described in the operating instructions or as marked on the appliance.

Grounding or Polarization:

Precautions should be taken so that the grounding or polarization means of an appliance is not defeated.

Power-Cord Protection:

Power supply cords should be routed so that they are not likely to be walked on or pinched by items placed upon or against them, paying particular attention to cords and plugs, convenience receptacles and the point where they exit from the appliance.

Cleaning:

The appliance should be cleaned only as recommended by the manufacturer.

Non-use Periods:

The power cord of the appliance should be unplugged from the outlet when left unused for a long period of time.

Object and Liquid Entry:

Care should be taken so that objects do not fall and liquids are not spilled into the enclosure through openings.

Damage Requiring Service:

The appliance should be serviced by qualified service personnel when:

- The power supply cord or the plug has been damaged; or
- Objects have fallen, or liquid has been spilled into the appliance; or
- The appliance has been exposed to rain; or
- The appliance does not appear to operate normally or exhibits a marked change in performance; or
- The appliance has been dropped, or the enclosure damaged.

Servicing:

The user should not attempt to service the appliance beyond that is described in the Operating Instructions. All other servicing should be referred to qualified service personnel.

FOREWORD

Dear Customer,

Welcome to the team of EURORACK users and thank you very much for expressing your confidence in BEHRINGER products by purchasing this unit.

It is one of my most pleasant tasks to write this letter to you, because it is the culmination of many months of hard work delivered by our engineering team to reach a very ambitious goal: To produce a compact mixer, which fully satisfies your and our expectations and delivers a superior sound quality, easy operation and technical specifications. In addition to that the mixer is affordable for almost every musician. The task to design the EURORACK MX1604A certainly meant a great deal of responsibility, which we assumed by focusing on you, the discerning user and musician. It also meant a lot of work and night shifts to accomplish this goal. But it was fun, too. Developing a product usually brings a lot of people together, and what a great feeling it is when everybody who participated in such a project can be proud of what we've achieved.

It is our philosophy to share our joy with you, because you are the most important member of the BEHRINGER family. With your highly competent suggestions for new products you've greatly contributed to shaping our company and making it successful. In return, we guarantee you uncompromising quality (manufactured under the ISO9000 certified management system) as well as excellent technical and audio properties at an extremely favorable price. All of this will enable you to fully unfold your creativity without being hampered by budget constraints.

We are often asked how we can make it to produce such high-grade devices at such unbelievably low prices. The answer is quite simple: it's you, our customers! Many satisfied customers means large sales volumes enabling us to get better conditions of purchase for components, etc. Isn't it only fair to pass this benefit back to you? Because we know that your success is our success, too!

I would like to thank all people whose help on "Project EURORACK MX802A" has made it all possible. Everybody has made very personal contributions, starting from the designers of the unit via the many staff members in my company to you, the user of BEHRINGER products.

My friends, it's been worth the effort!

Thank you very much,

A handwritten signature in black ink, appearing to read 'U. Behringer', with a long horizontal flourish extending to the right.

Uli Behringer

EURORACK®

Ultra-low noise 8-Channel Mic/Line Mixer

- ▲ 4 mono input channels with gold plated XLRs and balanced line inputs
- ▲ Ultra-low noise discrete mic preamps with +48 V phantom power
- ▲ 2 stereo input channels with balanced TRS jacks
- ▲ 2 additional multifunctional stereo line inputs
- ▲ Extremely high headroom – offering more dynamic range
- ▲ Balanced inputs for highest signal integrity
- ▲ Ultra-musical 3-band EQ on all channels
- ▲ Peak LEDs and switchable low-cut filter on all mono channels
- ▲ 2 aux sends per channel for external effects and monitoring
- ▲ Separate main mix, control room and headphone outputs
- ▲ 2-Track inputs assignable to main mix, control room / headphone outputs
- ▲ Highly accurate 12 segment bargraph meters
- ▲ High-quality sealed potentiometers
- ▲ Rugged design power supply ensures superior signal integrity
- ▲ State-of-the-art 4580 IC's and high quality components ensure crystal-clear audio performance and excellent noise figures
- ▲ Rugged construction ensures long life even under the most demanding conditions
- ▲ Manufactured under ISO9000 certified management system

MX802A

TABLE OF CONTENTS

1. INTRODUCTION	6
1.1 Architecture	6
1.2 Before you begin	6
1.2.1 PSU (power supply unit)	6
1.2.2 Warranty	7
1.2.3 Packing	7
2. MONO INPUT CHANNEL	7
2.1 Input level setting	7
2.2 Equalizer	7
2.3 Aux sends	7
2.4 Fading and panning	8
3. STEREO INPUT CHANNEL	8
3.1 Input level setting	8
3.2 Equalizer	8
3.3 Aux sends	8
3.4 Volume control and panning/balancing	8
4. MAIN SECTION	8
4.1 Aux sends	8
4.2 Stereo aux returns	9
4.3 Metering	9
4.4 2-track input / main mix output	9
4.5 Monitoring	9
5. SETTING UP	10
5.1 Desk normalization	10
5.2 Selecting inputs	10
5.3 Initializing channels for gain setting	10
5.4 Auditioning a signal and setting up a channel	11
5.5 Recording levels	11
5.6 Modification	11
6. CONNECTIONS	12
7. APPENDIX	13
7.1 Specifications	13
7. APPENDIX	14
7.1 Front & back views	14
7.2 Block diagram	15
7.3 Specifications	16
8. WARRANTY	17

1. INTRODUCTION

Congratulations. In purchasing our EURORACK MX802A you have acquired a mixer whose small size belies its incredible versatility and superlative audio performance. Your EURORACK is built to the same outstanding quality as our top-of-the range console, the BEHRINGER EURODESK MX9000.

We recommend that you experiment with your EURORACK away from the pressures of a recording session or live concert, in order to get a feel for it. It is a musical instrument. Learn to play it well.

Next to the specifications in the appendix you will find pages with drawings showing the front and rear panels of your EURORACK. Keep them turned over, lying to the left of the text pages, while studying the manual. All functions are numbered consistently throughout the manual, whether in the text or on an illustration.

1.1 Architecture

Mono input channels

Channels 1 - 4 are mono, with a choice of balanced mic or line inputs. The vintage-style high-current discrete mic amps are of the same incredible quality as those found on the acclaimed BEHRINGER EURODESK MX9000, while a large external power supply ensures low noise and superior transient response at all times.

Stereo input channels

A further 4 line inputs are configured as 2 stereo input channels. These are ideal for accepting outputs from MIDI and other electronic instruments.

Channel outputs

A high-quality rotary potentiometer feeds the main mix via a constant-power channel pan potentiometer.

Aux Send

There are two aux send busses on the MX802A, aux 1 is pre-fader, aux 2 is post-fader (the channel's volume control).

Stereo line inputs

There are two line-level stereo aux returns at the top of the output section. They can be used to return stereo effects or MIDI instruments etc.

In addition, a stereo tape input is provided, which may be routed to the main mix or the control room mix, giving the MX802A a total of 14 possible inputs during mixing. Channels 1 - 4 on the MX802A have overload LEDs, while the main mix output has 12-segment bargraph meters.

1.2 Before you begin

1.2.1 PSU (power supply unit)

Any amplifier circuit is limited in its transient response by the available current. Every mixer has numerous line level operational amplifiers (op-amps) inside. When being driven hard, many desks begin to show signs of stress due to power supply limitations. Not so with the EURORACK. The sound will always stay clean and crisp right up to the operating limits of the op-amps themselves, thanks to the generous 20 W external power supply unit.

 **Connect only the provided BEHRINGER power supply unit to the MX802A. Do not connect the PSU to the EURORACK while the PSU is connected to the mains supply. The correct starting sequence is: connect mixer and PSU and then connect the PSU to the mains.**

 **Be sure that there is enough space around the unit for cooling and please do not place the MX802A on high temperature devices such as power amplifiers etc. to avoid overheating.**

When switched on, parts of the desk and the power supply unit will become warm, this is normal during operation.

1.2.2 Warranty

Please take the time to fill out and return the warranty card within 14 days from the date of purchase, so as to be entitled to benefit from our extended warranty. Or use our online registration option available on the Internet at www.behringer.com.

1.2.3 Packing

Your BEHRINGER MX802A was carefully packed in the factory and the packaging was designed to protect the unit from rough handling. Nevertheless, we recommend that you carefully examine the packaging and its contents for any signs of physical damage, which may have occurred in transit.

 **If the unit is damaged, please do not return it to us, but notify your dealer and the shipping company immediately, otherwise claims for damage or replacement may not be granted. Shipping claims must be made by the consignee.**

2. MONO INPUT CHANNEL

Each mono channel comes with an XLR mic input [1](#) and a balanced line input on 1/4" jack [2](#). Phantom powering is switchable from the back panel [34](#). The gain circuit has a wide range from +10 dB to +60 dB, obviating the need for mic/line switching. The crucial operating input levels +4 dBu and -10 dBV are clearly and accurately marked [4](#).

2.1 Input level setting

Mic channel input level is determined by the GAIN control [4](#). In addition to main mix metering, a channel PEAK LED [11](#) illuminates when a channel is going into overload. These LEDs take their cue from post-EQ. This level sampling is particularly useful when using extreme EQ settings.

There is no SOLO or PFL function on the MX802A. To accurately set input follow the procedures given in section 5: "SETTING UP". However, if the PEAK LED does not light the input gain cannot be too high. If a reasonable input level is selected, auditioning a single signal should result in a reading of around 0 dB on the main mix meters [22](#), provided that both channel and output level controls are set to unity gain (0 dB).

2.2 Equalizer

All mono input channels are fitted with three-band EQ, plus a switchable low cut filter for eliminating unwanted subsonics. The upper [5](#) and lower [7](#) shelving controls have their frequencies fixed at 12 kHz and 80 Hz respectively. The Mid Range control [6](#) has a peaking response, with Q fixed at 2 octaves, frequency at 2.5 kHz. All three bands have up to 15 dB of cut and boost, with a centre detent for "off". The low cut filter [3](#), slope at 18 dB/oct., -3 dB at 75 Hz, is ideally suited for reducing floor rumble, breathing noises and popping, woolly bottom end etc.

 **The combination of shelf boost at 80 Hz together with low cut at 75 Hz results in a peaking response, useful for adding warmth to vocals and instruments, and a firm bottom to kick drums and basses, without losing control of low frequency speaker cones.**

2.3 Aux sends

Both aux sends are mono and post-EQ. Aux send 1 [8](#) is set pre-fader, while aux send 2 [9](#) is post-fader.

For almost all FX send purposes, you will want aux sends to be post-fader, so that when a fader level is adjusted, any reverb send from that channel follows the fader. Otherwise, when the fader is pulled down, the reverb from that channel would still be audible. For cueing purposes, Aux Sends will usually be set pre-fader, i.e. independent of the channel fader.

2.4 Fading and panning

Level to the main mix bus is ultimately determined by the channel volume control [12].

Channel pan [10] positions the output of the channel in the stereo field. Its constant-power design ensures there are no level discrepancies whether a signal is hard-panned, centre-stage or somewhere inbetween. Such pinpoint accuracy will be a revelation if you have been working on consoles with lower quality circuits.

3. STEREO INPUT CHANNEL

Each stereo channel comes with two balanced line level inputs on 1/4" TRS jacks [29], for left and right signals. When only the left input is connected, the channel operates in mono.

3.1 Input level setting

The stereo inputs are designed for any line level signal. Most line level sources such as MIDI instruments and FX units will have their own output level control. Those that don't, like CD players, all have an output level within the scope of the MX802A. When the channel and master fader are set to unity gain the meters should read between -4 and +7 dB. Remember that there is 15 dB gain on both the channel as well as master fader.

3.2 Equalizer

There are no low cut filters on stereo channels, otherwise the EQ is in principle identical to that on mono channels (see 2.2), except that the EQ is stereo, of course!

A stereo equalizer is generally preferable to using two mono equalizers when EQ-ing a stereo signal, as often discrepancies between left and right settings can occur.

3.3 Aux sends

It is the same as for mono channels (see 2.3). Note that a mono sum is taken from the stereo input.

3.4 Volume control and panning/balancing

The only difference here to the mono channel described in 2.4 is in the implementation of the balance control [13]. When a channel is run in stereo, this control determines the relative balance of the left and right channel signals being sent to the left and right main mix buses. For example, with the balance control turned fully clockwise, only the right portion of the channel's stereo signal will be added to the main mix.

If a stereo channel is run in mono (only the left input connected), the balance control acts as a pan in the normal way.

4. MAIN SECTION

4.1 Aux sends

Aux sends are provided on unbalanced 6.3 mm jacks [25]. Please adjust the input level control of your effects unit to match the output level of your EURORACK. This can be done when typical signals are run through the MX802A and the aux sends are set to center (0 dB). If your effects unit does not have an input gain and the effects levels seems too low, remember that every channel aux send has up to 15 dB gain, which should be more than enough to drive any effects unit.

4.2 Stereo aux returns

There are two additional stereo line inputs (aux returns 1 and 2) on your MX802A. Their level can be adjusted with [14] and [19]. Aux returns 1 is permanently assigned to the main mix. If you connect a jack only to the left socket, the aux return 1 operates in mono. Aux return 2 can be switched between the main mix and the cue feed (aux send 1) via a switch marked “FX TO AUX 1” [15]. This enables you to provide a wet cue mix (signal with effect i.e. reverb) for the headphones or foldback speakers.

If no connection is made to aux return 2, the signal is “normalled” (connected directly) to aux return 1. Depressing “FX TO AUX 1” will then feed the signal from aux return 1 into the cue feed (aux send 1) and can be controlled in level independently with aux return 2. This feature is primarily useful when you are using one effect for the main mix and for the foldback speakers.

 **When using aux send 1 as a second (pre-fader) effects send and aux return 2 as the effect input, do not engage “FX TO AUX 1” . The connection from aux return 2 to aux send 1 could cause feedback.**

There are exceptions. For instance, when you want to send one effect into another, e.g. delay into chorus etc.

 **Sometimes an engineer wants to narrow the stereo width of a reverb field. To do this you will have to come back on two mono channels to get independent panorama for the left and right signals.**

4.3 Metering

Main mix level is displayed on a pair of accurate 12-segment bargraph peak meters [22]. Two further LEDs indicate Power on [21] and +48 V DC phantom power present [20].

The main mix bargraph meters should average around 0 dB during loud passages. If they read persistently higher, or are peaking above +10 dB (top segment of the display) reduce either the main mix volume and/or the channel volume, or (as a last resort) channel input gain or instrument / FX unit output level.

4.4 2-track input / main mix output

Input

A 2-track input, on RCA phono jacks [26], provides easy connection to DAT and other professional and semiprofessional audio equipment. The 2-track input is primarily for auditioning mix playback from tape. Switch [16] “2TK TO CTRL ROOM” routes this signal to the studio monitors. However, it can also be routed to the main mix via switch [17] “2TK TO MIX”. Here [16] should be disengaged, or you will be listening to the 2-track signal twice over! With [17] depressed you have another stereo line input available to the mix.

 **The 2-track input could be “normalled” to the output of a HiFi preamp, allowing you to monitor extra sources such as vinyl, cassette, CD etc.**

Output

A single pair of electronically balanced TRS jacks [28] deliver the main mix output to your 2-track recorder (or PA system). RCA phono jack outputs [27] are also provided for easy connection to DAT, cassette desk etc.

Level is ultimately determined by a precision main mix volume control [23].

4.5 Monitoring

The MX802A has a separate headphone output [30]. The phones signal follows the control room output [31]. A single volume control [18] sends the level to the headphones and main monitors.

The L/R meters follow the main mix.

5. SETTING UP

Experience tells us that the cables in a studio environment get tangled very quickly (inviting mistakes). A patchfield will facilitate patching and repatching considerably. The BEHRINGER ULTRAPATCH PRO PX2000 makes patching easier and trouble free, increasing both ergonomics and productivity.

5.1 Desk normalization

All board settings should be set to the normal default condition before or after every session. Usually volumes are set to zero (minus infinity), EQs set flat, and Aux Sends turned fully counter-clockwise etc.

5.2 Selecting inputs

1) Mono channels accept mic or line inputs. If you are using the mic input, make sure nothing is connected to the line input (and vice-versa).

 **The mic inputs are more sensitive than the line inputs. Do not connect mics with phantom power switched on. Never use unbalanced mic cables with the phantom power switched on ever! Shorting the +48 V to earth can cause serious damage.**

2) Stereo channels accept any line level signals. Any stereo channel can be run in mono simply by connecting into the left jack socket only. These channels are suitable for a variety of line-level sources including MIDI instruments and tape returns from multitrack.

3) Stereo aux returns are primarily designed for returning effects units, though these too may be given over to tape returns or MIDI instrument outputs.

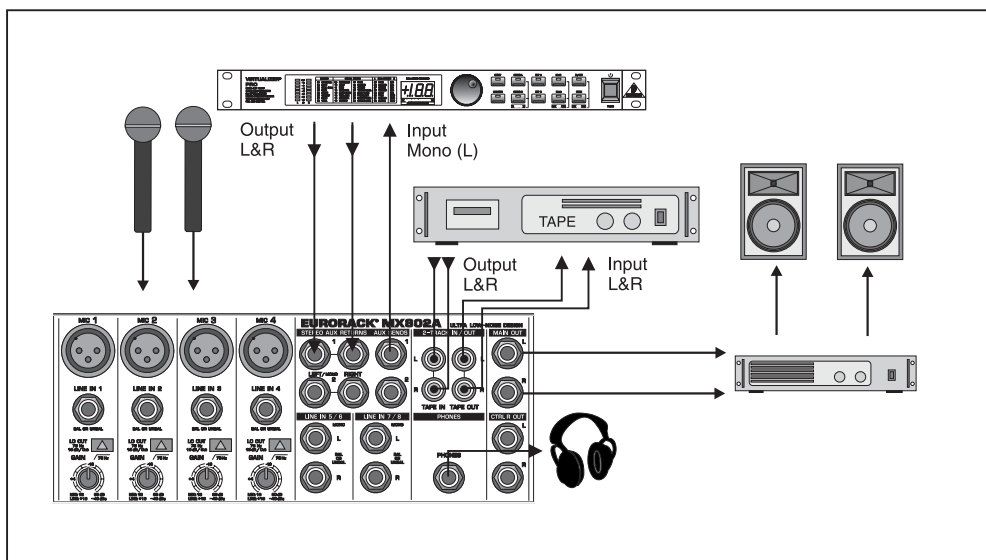







Fig. 5.1: Setup example

5.3 Initializing channels for gain setting

- 1) Set Gain to minimum and all aux sends to off (fully counter-clockwise).
- 2) Set EQ to flat (all knobs at 12 o'clock).
- 3) Set the output level to unity gain ( set to "0").

5.4 Auditioning a signal and setting up a channel

- 1) Where applicable, engage the low cut switch  for most mics, except for signals with desired very low frequency content.
- 2) Turn up channel volume to unity gain ( to "0"). All other channel volume controls should be set fully counter-clockwise (minus infinity).
- 3) Generate a signal, i.e. a voice through a microphone. There should now be some activity at the bargraph meters .
- 4) For mic channels: Adjust the gain control  until transient peaks are regularly hitting +6 dB. Continuous signals should not exceed 0 dB.
- 5) For stereo channels and other stereo line inputs, use the output volume of the source instrument or FX unit to effect gain adjustment until transient peaks are regularly hitting +6 dB. Continuous signals should not exceed 0 dB.
- 6) Altering EQ will affect a channel's gain. If EQ is adjusted at any time, repeat steps 4 or 5.
- 7) Turn the channel's volume control fully counter-clockwise. Move onto next channel and repeat steps 1 thru 7.
- 8) Once all channel inputs have been set for level, turn all active channel level controls back to 0 dB. You are now ready to start mixing.

5.5 Recording levels

When recording to digital, it's a good idea to keep the recorder's peak meters below 0 dB. Most (not all, esp. samplers) read 0 dB with some headroom left. This is because, unlike with analog, the onset of digital distortion is as sudden as it is horrible. If you really want to take your recording level to the limit (and fully exploit 16-bit digital's 96 dB dynamic range for example), you'll have to do some calibrating. How to do it? Well, you could run a tone at 0 dB from the mixer and use that as your DAT or ADAT reference. But your DAT or ADAT may be way under its maximum input limit. Probably a better way to work out just how hard you can drive your recorder is to incrementally increase the record level until the onset of digital distortion, subtract, say, 5 or 10 dB, and never exceed that level. Engage "peak hold" on your recorder before recording if you want to confirm that you haven't. Peak meters read more-or-less independent of frequency. Aim for 0 dB recording level for all signals.

5.6 Modification

The following modifications require you to do some soldering. Attempt only if you are experienced in using an iron on PCBs. Otherwise, refer to qualified personnel. After modification the BEHRINGER warranty becomes discretionary.

Links should not be threaded into holes on the PCB. They should be soldered to the tinned areas around the holes, and bowed slightly upwards in between.

Mono channel aux send 2 > pre-fader

All mono channel aux sends 2 are post-fader. If you want to convert them, carry out the modification described below to each mono channel you want to be altered. The right PCB area is indicated by a yellow printing (see figures below).

- 1) Switch desk off and disconnect it from the mains supply!
- 2) Cut the "post" track.
- 3) Add in a "pre" link.

Repeat for all mono channels you want to be modified.

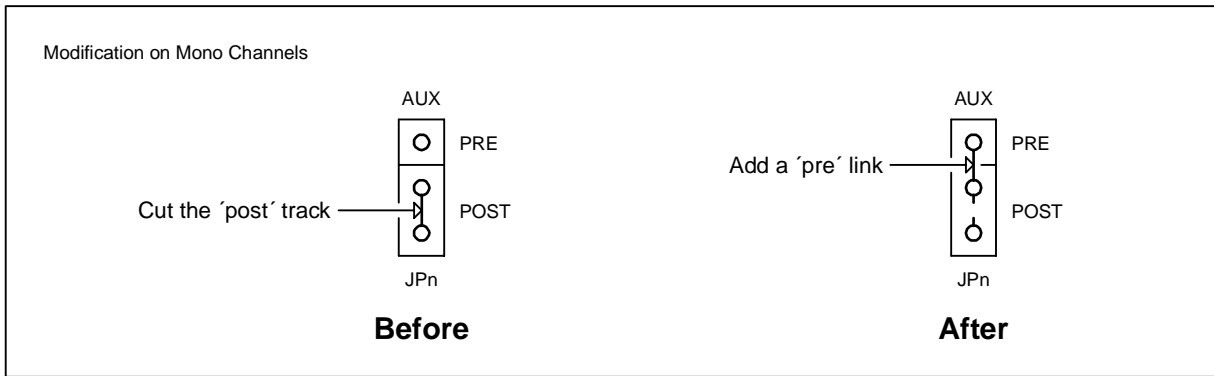

6. CONNECTIONS

You will need a lot of cables for different purposes – see the following figures to make sure you have got the right ones. Unbalanced equipment may be connected to balanced inputs/outputs. Either use mono 1/4" jacks or connect ring and sleeve of TRS jacks.

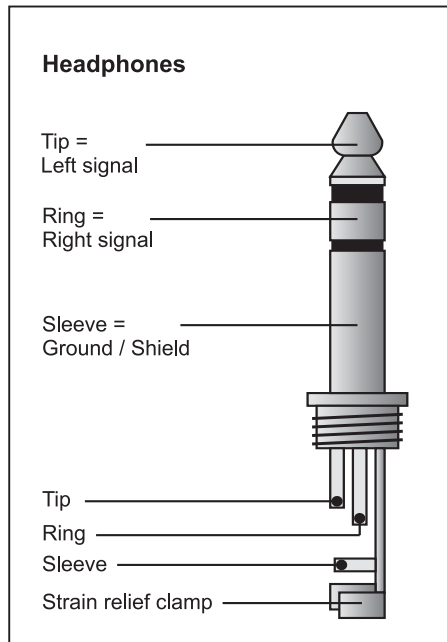

Fig. 6.1: Headphone connection

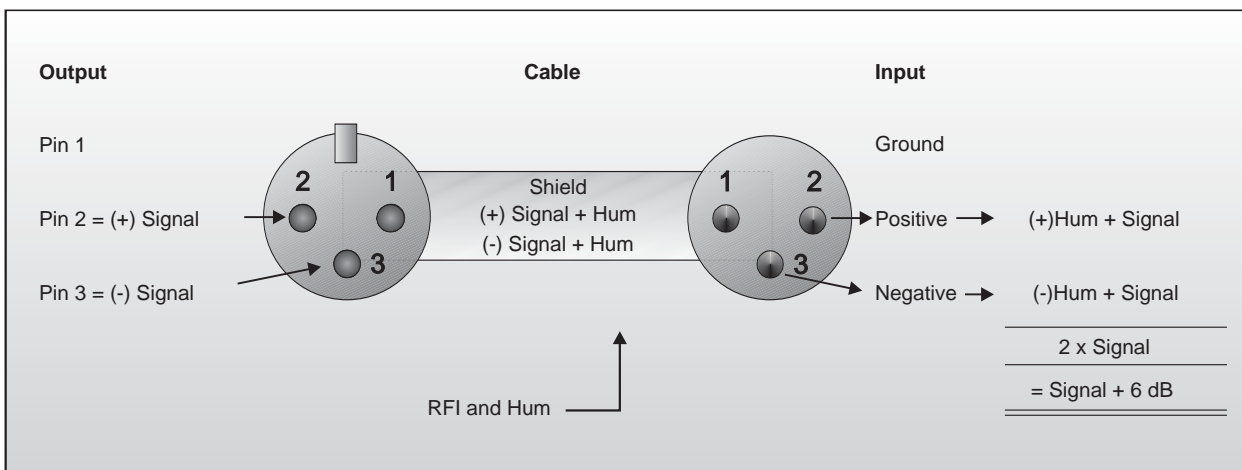

Fig. 6.2: Compensation of interference with balanced connections

Phantom power (+48 V DC) is provided. This can be switched on or off by the +48 V phantom switch [34](#).

⚠ Care should be taken NOT to plug mics into the console (or stagebox) while the phantom power is on. Also, mute the monitor/PA speakers when turning phantom power on or off. Allow the system to adjust for a couple of seconds after engaging phantom power before setting input gains.

If possible, connect the unit to other devices in a balanced configuration to allow for maximum interference immunity.

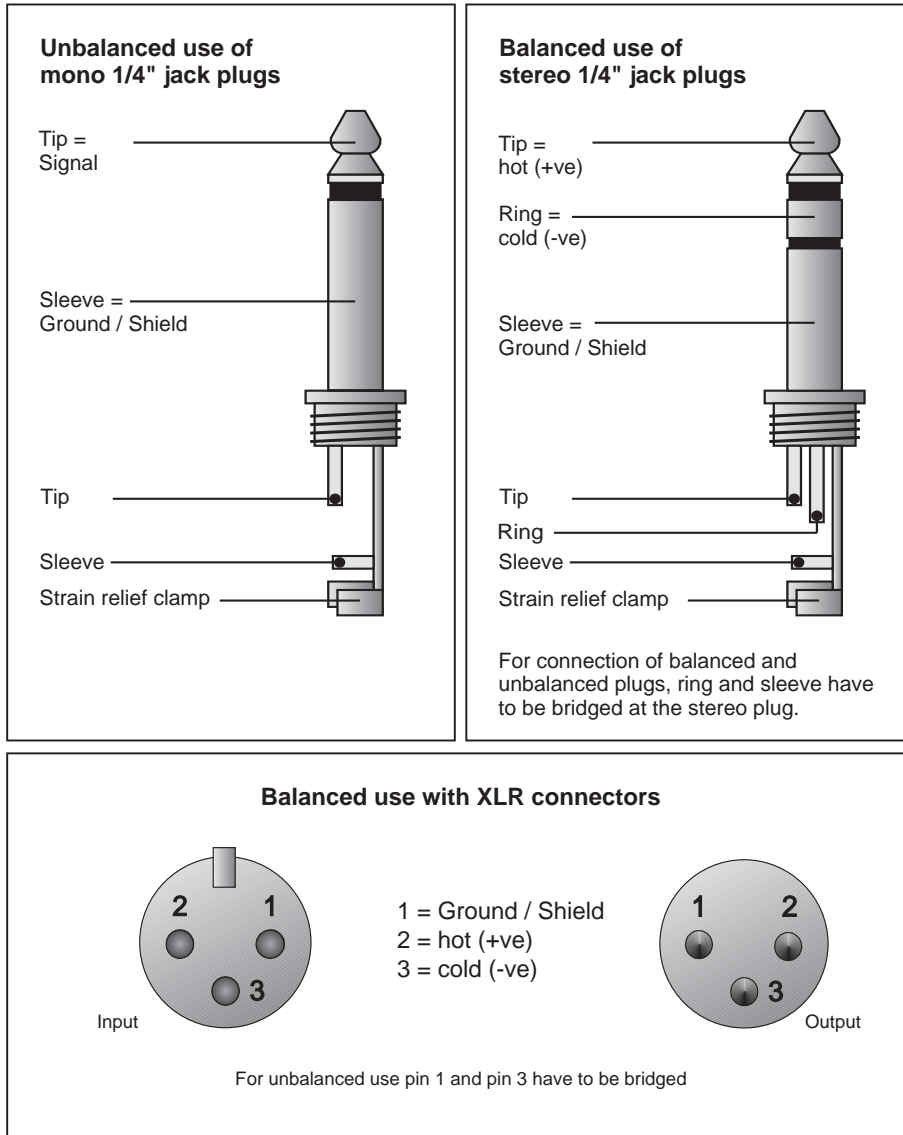
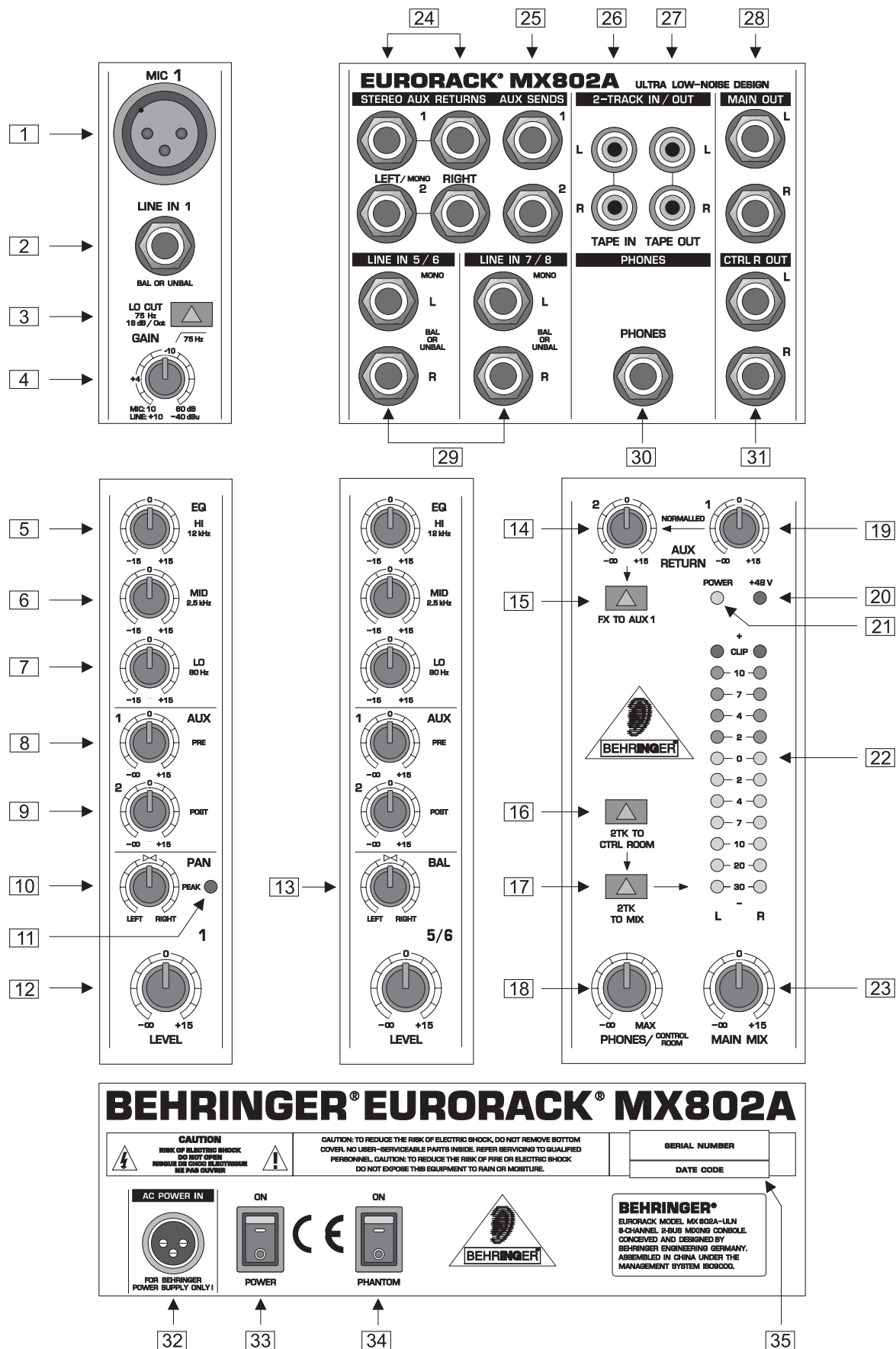

Fig. 6.3: Different plug types

7. APPENDIX

7.1 Front & back views



7.2 Block diagram

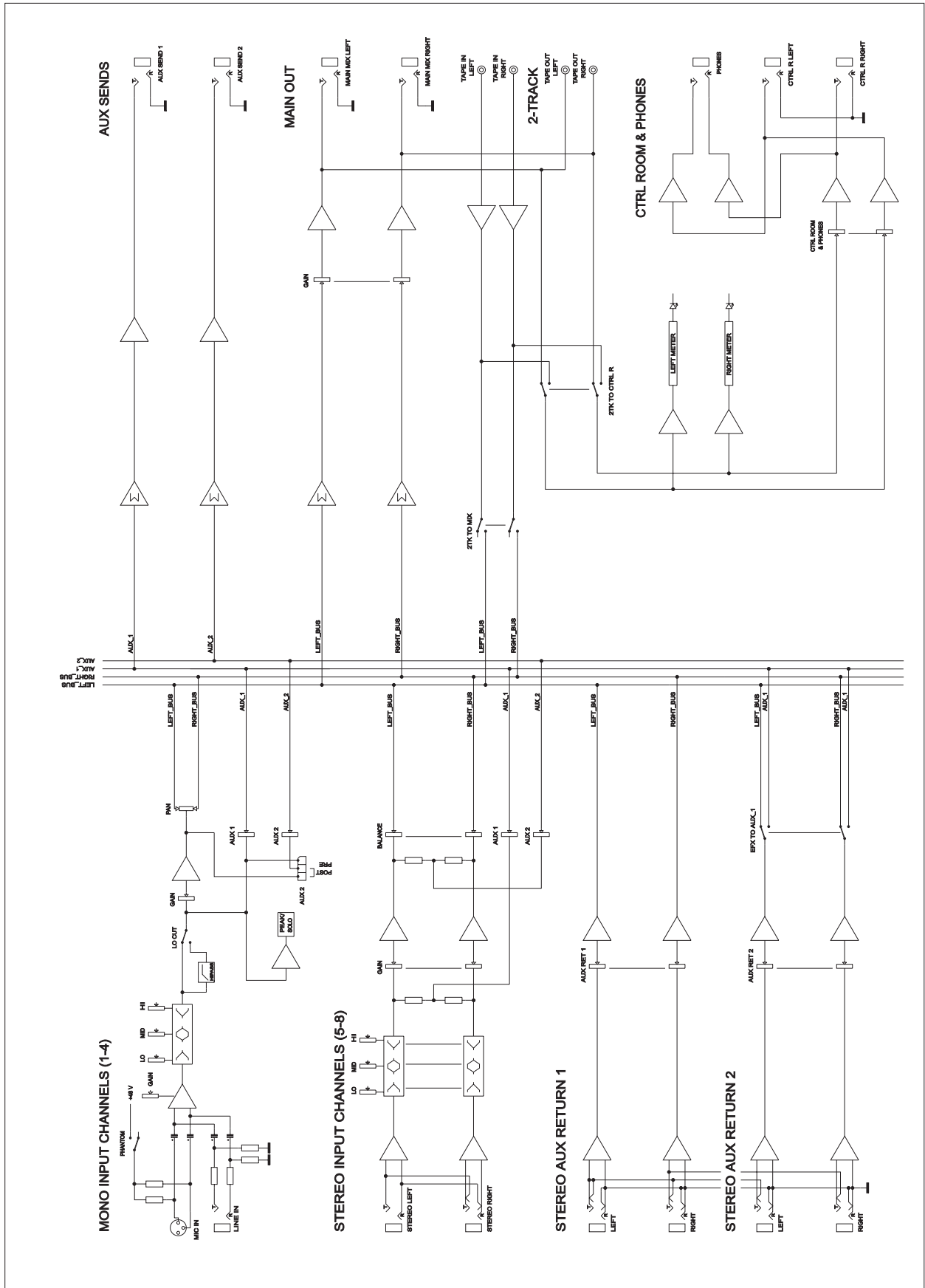

7.3 Specifications

Mono inputs

Mic input	electronically balanced, discrete input configuration
Bandwidth	10 Hz to 60 kHz, +/- 3 dB
Distortion (THD&N)	0.007% at +4 dBu, 1 kHz, bandwidth 80 kHz
Mic E.I.N. (22 Hz - 22 kHz)	-129.5 dBu, 150 Ohm source -117.3 dBq, 150 Ohm source -132.0 dBu, input shorted -122.0 dBq, input shorted
Gain range	+10 dB to +60 dB

Line input	electronically balanced
Bandwidth	10 Hz to 60 kHz, +/- 3 dB
Distortion (THD&N)	0.007% at +4 dBu, 1 kHz, bandwidth 80 kHz
Line level range	+10 dBu to -40 dBu

Equalization	
Hi shelving	12 kHz, +/- 15 dB
Mid range	2.5 kHz, +/- 15 dB
Lo shelving	80 Hz, +/- 15 dB

Stereo inputs

Line input	unbalanced
Bandwidth	10 Hz to 55 kHz, +/- 3 dB
Distortion (THD&N)	0.007% at +4 dBu, 1 kHz, bandwidth 80 kHz

Equalization	
Hi shelving	12 kHz, +/- 15 dB
Mid range	2.5 kHz, +/- 15 dB
Lo shelving	80 Hz, +/- 15 dB

Main mix section

Max output	+22 dBu balanced
Aux send max out	+22 dBu unbalanced
Control room out	+22 dBu unbalanced
Signal-to-noise ratio	112 dB, all channels at unity gain

Power supply

Mains voltages	USA/Canada	115 V ~, 60 Hz, power supply unit MXUL2
	U.K./Australia	240 V ~, 50 Hz, power supply unit MXUK2
	Europe	230 V ~, 50 Hz, power supply unit MXEU2
	Japan	100 V ~, 60 Hz, power supply unit MXJP2

Physical

(H * W * D)	1 1/2" (37 mm) * 8 4/5" (225 mm) * 10 3/5" / 11" (270 / 280 mm)
Net weight	2.4 kg (PSU not included)
Gross weight	3.9 kg

BEHRINGER is constantly striving to maintain the highest professional standards. As a result of these efforts, modifications may be made from time to time to existing products without prior notice. Specifications and appearance may differ from those listed or shown.

8. WARRANTY

§ 1 WARRANTY CARD/ONLINE REGISTRATION

To be protected by the extended warranty, the buyer must complete and return the enclosed warranty card within 14 days of the date of purchase to BEHRINGER Spezielle Studiotechnik GmbH, in accordance with the conditions stipulated in § 3. Failure to return the card in due time (date as per postmark) will void any extended warranty claims.

Based on the conditions herein, the buyer may also choose to use the online registration option via the Internet (www.behringer.com or www.behringer.de).

§ 2 WARRANTY

1. BEHRINGER (BEHRINGER Spezielle Studiotechnik GmbH including all BEHRINGER subsidiaries listed on the enclosed page, except BEHRINGER Japan) warrants the mechanical and electronic components of this product to be free of defects in material and workmanship for a period of one (1) year from the original date of purchase, in accordance with the warranty regulations described below. If the product shows any defects within the specified warranty period that are not due to normal wear and tear and/or improper handling by the user, BEHRINGER shall, at its sole discretion, either repair or replace the product.

2. If the warranty claim proves to be justified, the product will be returned to the user freight prepaid.

3. Warranty claims other than those indicated above are expressly excluded.

§ 3 RETURN AUTHORIZATION NUMBER

1. To obtain warranty service, the buyer (or his authorized dealer) must call BEHRINGER (see enclosed list) during normal business hours **BEFORE** returning the product. All inquiries must be accompanied by a description of the problem. BEHRINGER will then issue a return authorization number.

2. Subsequently, the product must be returned in its original shipping carton, together with the return authorization number to the address indicated by BEHRINGER.

3. Shipments without freight prepaid will not be accepted.

§ 4 WARRANTY REGULATIONS

1. Warranty services will be furnished only if the product is accompanied by a copy of the original retail dealer's invoice. Any product deemed eligible for repair or replacement by BEHRINGER under the terms of this warranty will be repaired or replaced within 30 days of receipt of the product at BEHRINGER.

2. If the product needs to be modified or adapted in order to comply with applicable technical or safety standards on a national or local level, in any country which is not the country for which the product was originally developed and manufactured, this modification/adaptation shall not be considered a defect in materials or workmanship. The warranty does not cover any such modification/adaptation, irrespective of whether it was carried out properly or not. Under the terms of this warranty, BEHRINGER shall not be held responsible for any cost resulting from such a modification/adaptation.

3. Free inspections and maintenance/repair work are expressly excluded from this warranty, in particular, if caused by improper handling of the product by the user.

This also applies to defects caused by normal wear and tear, in particular, of faders, potentiometers, keys/buttons and similar parts.

4. Damages/defects caused by the following conditions are not covered by this warranty:

- ▲ misuse, neglect or failure to operate the unit in compliance with the instructions given in BEHRINGER user or service manuals.
- ▲ connection or operation of the unit in any way that does not comply with the technical or safety regulations applicable in the country where the product is used.
- ▲ damages/defects caused by force majeure or any other condition that is beyond the control of BEHRINGER.

5. Any repair or opening of the unit carried out by unauthorized personnel (user included) will void the warranty.

6. If an inspection of the product by BEHRINGER shows that the defect in question is not covered by the warranty, the inspection costs are payable by the customer.

7. Products which do not meet the terms of this warranty will be repaired exclusively at the buyer's expense. BEHRINGER will inform the buyer of any such circumstance. If the buyer fails to submit a written repair order within 6 weeks after notification, BEHRINGER will return the unit C.O.D. with a separate invoice for freight and packing. Such costs will also be invoiced separately when the buyer has sent in a written repair order.

§ 5 WARRANTY TRANSFERABILITY

This warranty is extended exclusively to the original buyer (customer or retail dealer) and is not transferable to anyone who may subsequently purchase this product. No other person (retail dealer, etc.) shall be entitled to give any warranty promise on behalf of BEHRINGER.

§ 6 CLAIM FOR DAMAGES

Failure of BEHRINGER to provide proper warranty service shall not entitle the buyer to claim (consequential) damages. In no event shall the liability of BEHRINGER exceed the invoiced value of the product.

§ 7 OTHER WARRANTY RIGHTS AND NATIONAL LAW

1. This warranty does not exclude or limit the buyer's statutory rights provided by national law, in particular, any such rights against the seller that arise from a legally effective purchase contract.

2. The warranty regulations mentioned herein are applicable unless they constitute an infringement of national warranty law.

The information contained in this manual is subject to change without notice. No part of this manual may be reproduced or transmitted in any form or by any means, electronic or mechanical, including photocopying and recording of any kind, for any purpose, without the express written permission of BEHRINGER Spezielle Studiotechnik GmbH.

BEHRINGER, EURORACK and EURODESK are registered trademarks.

ALL RIGHTS RESERVED.

© 2001 BEHRINGER Spezielle Studiotechnik GmbH.

BEHRINGER Spezielle Studiotechnik GmbH, Hanns-Martin-Schleyer-Str. 36-38, 47877 Willich-Münchheide II, Germany

Tel. +49 (0) 21 54 / 92 06-0, Fax +49 (0) 21 54 / 92 06-30